

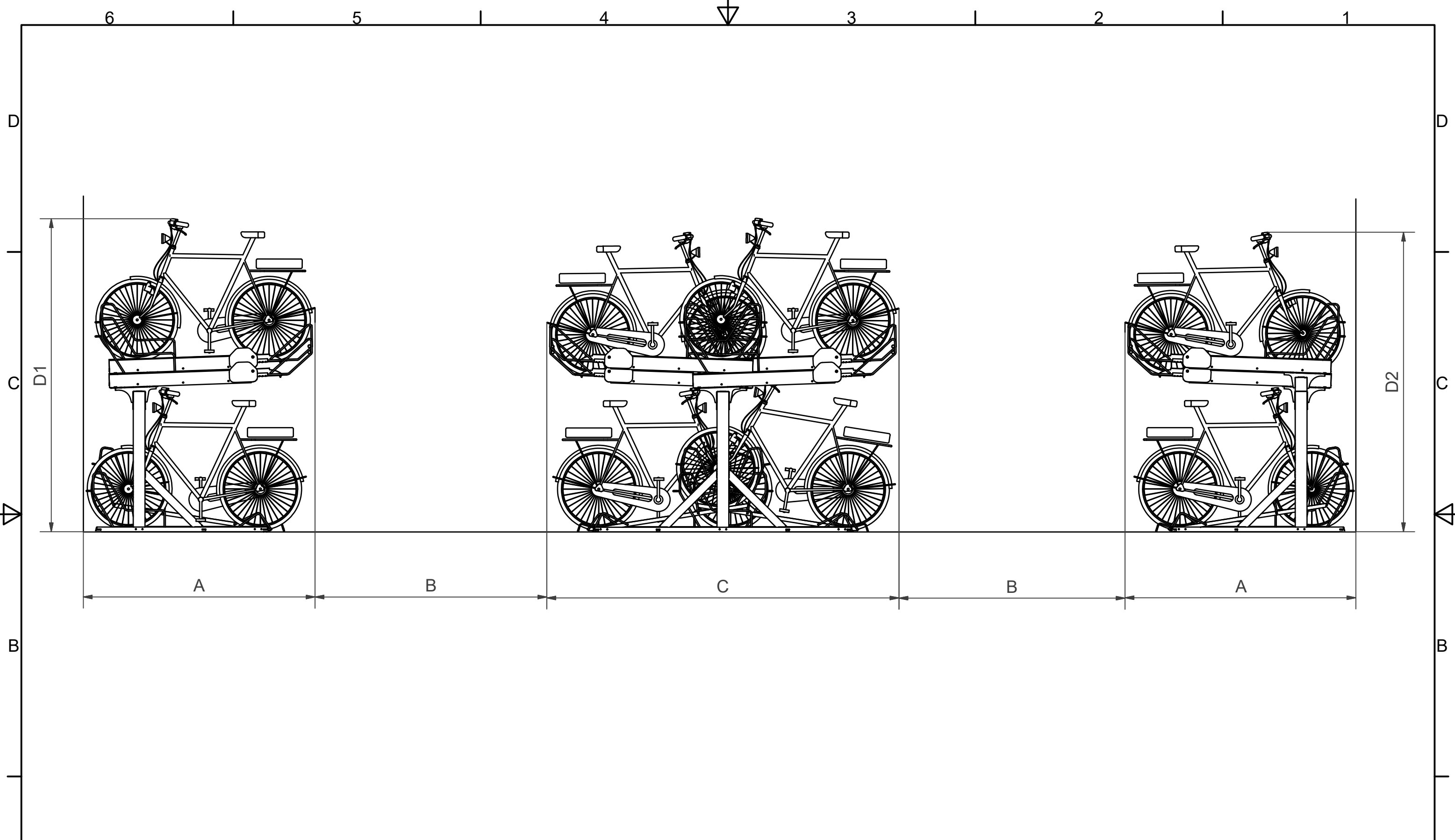

				Velo-Up Regular		
<b>pittman</b>		traffic & safety equipment		1:15		
✉ sales@pittmantraffic.com				P. de Laat		
☎ (01) 531 2111				16-5-2019		
				A3		



Product	A	B	C	D1	D2	375	400	500	550	575
Velo-Up E-Bike	1945	2100-1900	2990	2705	2585	x	x			
Velo-Up Flex	2100	2100-1900	n.v.t.	2700	2580			x	x	x
Velo-Up Fixed	2100	2100-1900	n.v.t.	2700	2580			x	x	x
Velo-Up Low	1995	2100-1900	3090	2655	2535	x	x			
Velo-Up Regular	1880	2100-1900	2910	2700	2580	x	x			
Velo-Up Budget	1890	2100-1900	2898	2700	2580	x	x			



**traffic & safety  
equipment**

sales@pittmantraffic.com  
(01) 531 2111



3-5-2019

HOH 375  
Dubbelzijdig

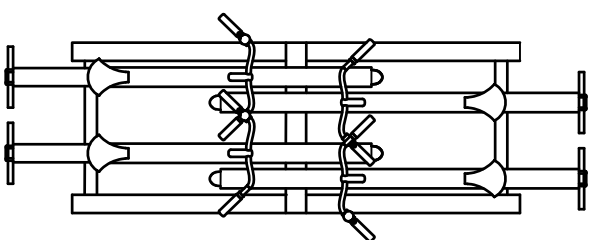
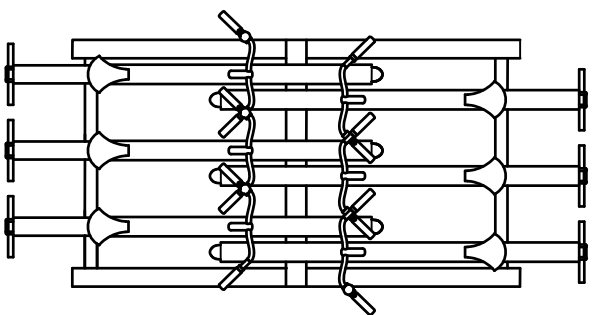
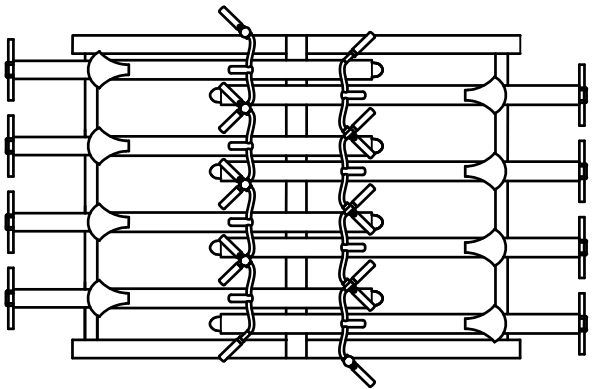
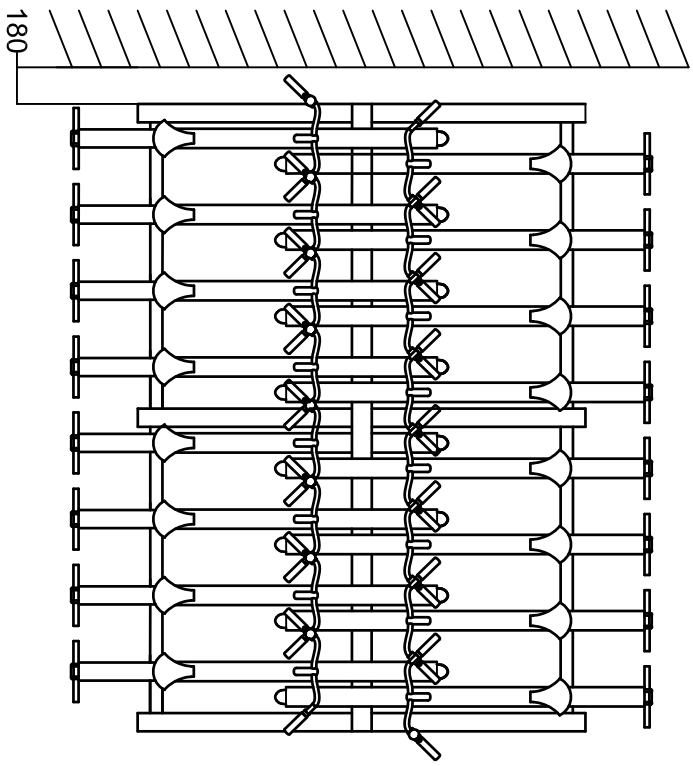

HOH 375  
Enkelzijdig

